

Compressed Gas Cylinder Safety And Management

INTEGRATED ENVIRONMENTAL SERVICES, INC.

Atlanta, Georgia

Presented by:

Jeffrey Gold



INTEGRATED
ENVIRONMENTAL
SERVICES

Situation



Response ???



Key Points To Remember!

- ▶ **Cylinders that have been physically damaged, submerged, burned, or buried are probably deteriorated and must be handled very carefully.**
- ▶ **Do not rely on a cylinder's color as a key to identification.**
- ▶ **Physical structure and valve configuration are keys to identifying unknown cylinders.**
- ▶ **Unknown cylinders may not be legally transported unless overpacked.**
- ▶ **Even common gases such as oxygen and acetylene can pose serious hazards.**
- ▶ **When a gas is heated, its pressure increases or its volume increases.**
- ▶ **Cylinders and the gases they contain pose unique hazards and must be handled very carefully....every time!**

Topics

- **What is a compressed gas?**
- **Hazardous Properties of Compressed Gases**
- **Gas Cylinder Identification**
- **Specialized Handling Equipment**
- **Emergency and Remedial Procedures**

Compressed Gases

Examples of Compressed Gases

Nitrogen

Oxygen

Acetylene

Propane

Chloropicrin

Chlorine

Methyl Bromide

Phosphine

Ammonia



Hazardous Properties

- ▶ **Pressure**
- ▶ **Flammable**
- ▶ **Toxic**
- ▶ **Corrosive**
- ▶ **Explosive**
- ▶ **Asphyxiant**



Physical Hazards

Pressure

- Compressed gas contains large amounts of kinetic energy.
- Pressurized gas released through a small opening behaves like a rocket engine.
- Cylinders can be propelled with enormous force from released gas.
- Full-sized cylinder can hold the equivalent energy of 1 lb. TNT.

Burns/Frostbite

- When gas expands as it leaves the cylinder and it cools very rapidly.
- Cryogenic or liquefied gas are cooled to -60 F and colder (N₂ -320 F).



Chemical Hazards

Flammability

▶ Flammability – 3 Key Ingredients

- A concentration of gas within its flammable limits.
- An oxidizing agent (eg. air).
- An ignition source.

▶ Flammability Limits

- A range of concentrations in air where a gas will burn.
- Lower Explosive Limit (LEL)
- Upper Explosive Limit (UEL)
- 10% LEL = Stop Work

▶ Instrumentation

- Explosimeter

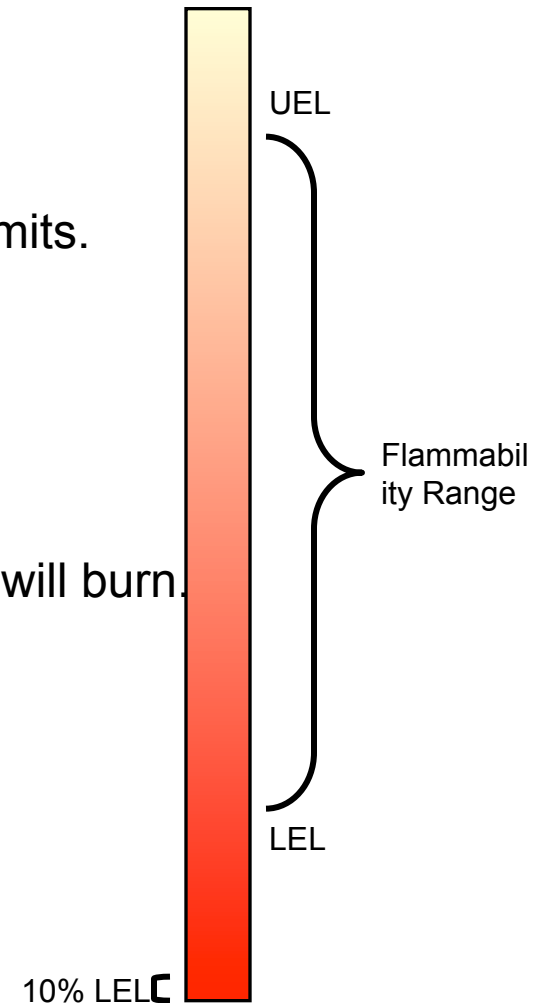

Chemical Hazards

Toxics

▶ Gases which are poisonous.

- Range from Class A poisons (very toxic) to irritants (low toxicity).
- Poison gases interfere with normal cell metabolism causing illness or death.
- Should only be handled when using respiratory protection devices (respirators).

▶ Examples

- Methyl Bromide
- Chloropicrin
- Phosphine

▶ Instrumentation

- Toxic Gas Monitor/SPM



Chemical Hazards

Asphyxiants

- ▶ **Gases which displace oxygen from the environment or body.**
 - Simple asphyxiants.
 - Chemical asphyxiants.
- ▶ **Examples**
 - Nitrogen (simple)
 - Carbon monoxide (chemical)
 - Hydrogen cyanide (chemical)
- ▶ **Instrumentation**
 - Oxygen meter

Chemical Hazards

Oxidizers

- ▶ **Material which accelerates or causes other materials to burn.**
 - Decompose violently when heated
 - Very corrosive to skin and other human tissue.

- ▶ **Examples**

- Oxygen
- Chlorine
- Nitrous Oxide

- ▶ **Instrumentation**

- Toxic Gas Monitor/SPM



Chemical Hazards

Corrosives

▶ Gases which attack human tissue or other material

- Acid gases (chlorine).
- Alkaline gases (ammonia).
- Protective equipment must protect both skin and respiratory system.

▶ Examples

- Hydrogen chloride
- Chlorine
- Ammonia

▶ Instrumentation

- Toxic Gas Monitor/SPM



Chemical Hazards

Threshold Limit Values (TLV)/Odor Thresholds - Examples

Chemical	TLV	Odor Threshold
Chlorine	1 ppm	3.5 ppm
Ammonia	25 ppm	5 ppm
Methyl Bromide	20.0 ppm	? ppm
Sulfur Dioxide	5 ppm	0.8 ppm
Hydrogen Sulfide	10 ppm	<1 ppm
Nitrogen Dioxide	3 ppm	5 ppm
Hydrogen Chloride	5 ppm	10 ppm

Gas Cylinder Identification

- Markings
- Configuration
- Valve
- Valve Protection (Cap or Collar)
- Pressure Relief Device
- Defects or Damage

Cylinder Markings

▶ **Cylinders must be marked to indicate:**

- Manufacturing specification (eg. 3AA, 4B)
- Design service pressure
- Manufacturer's serial number
- Inspector's symbol
- Manufacturer's symbol
- Initial qualification hydrostatic test date
- Overfill indication, if permitted (+)
- 10-year re-test indication, if permitted (★)

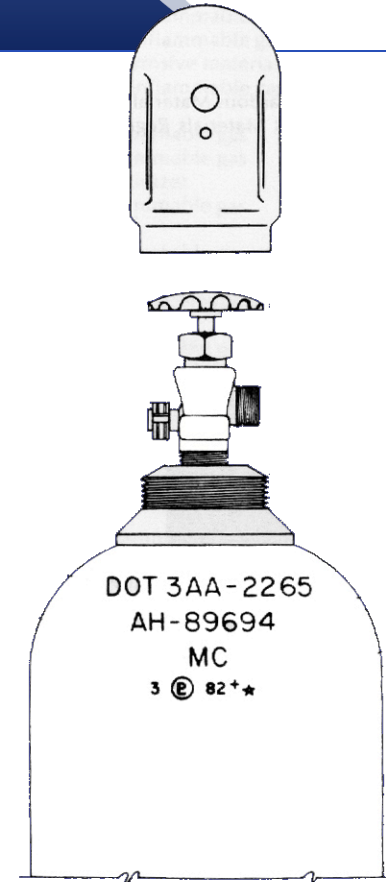

Example: DOT-3A2400 66548 ABC DEF Chemical Co. 4-XY-86

Cylinder Configurations

- ▶ **DOT or ICC cylinders range in size from 50 ml sample cylinders to 200 pound ammonia cylinders.**
- ▶ **Low-pressure cylinders (900 psig and lower) are generally characterized by:**
 - Larger diameter
 - “Flattened” shoulder area
 - Foot ring at base of cylinder
 - Welded seams
- ▶ **High-pressure cylinders (900 psig and higher) are generally characterized by:**
 - Tall and slender shape
 - Rounded shoulder
 - Concave bottoms with no foot rings
 - Absence of any welded seams

Cylinder Configurations

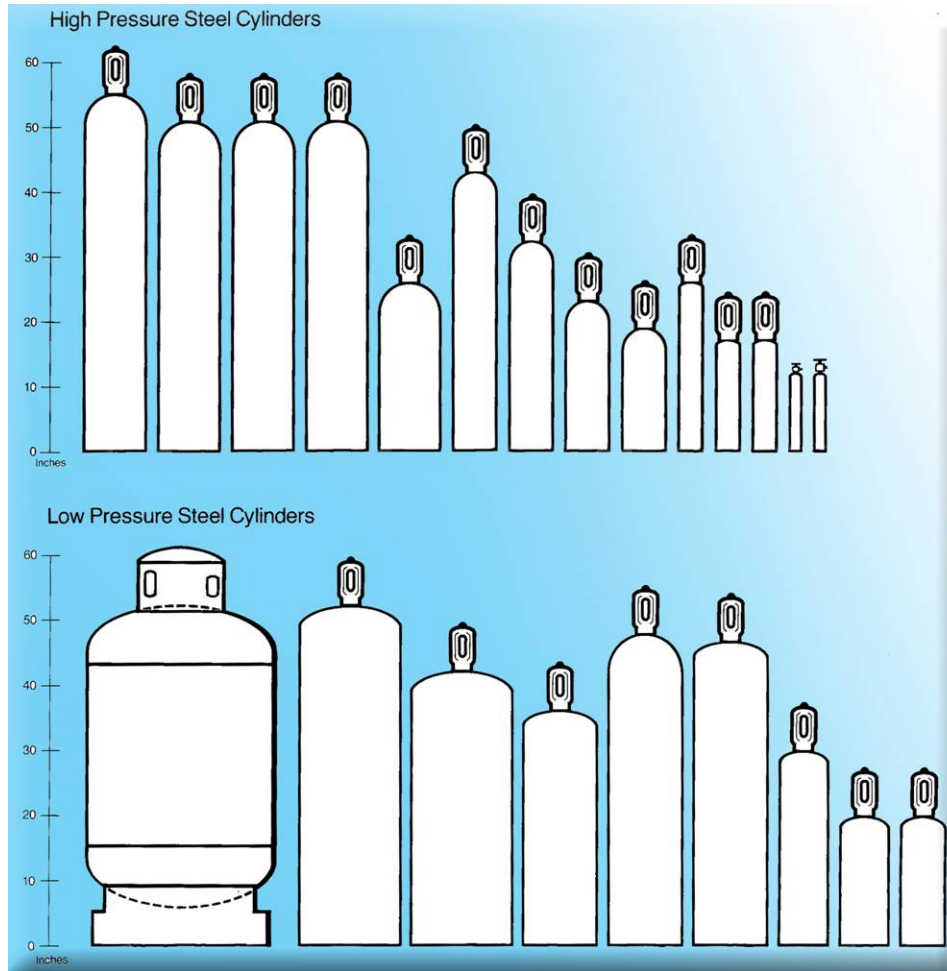

Acetylene Cylinders

- ▶ **Acetylene cylinders are unique among the family of gas cylinders.**
 - Each cylinder contains a porous, monolithic mass (usually asbestos).
 - Each cylinder contains liquid acetone.
- ▶ **Acetylene gas is dissolved in the acetone.**

DANGER!!

- *Acetylene can autodeTONATE if pressurized.*
- *Never transfill acetylene into another cylinder.*
- *Open and close valves slowly to avoid pressure surges.*
- *Never use acetylene around any sources of sparks or flames.*

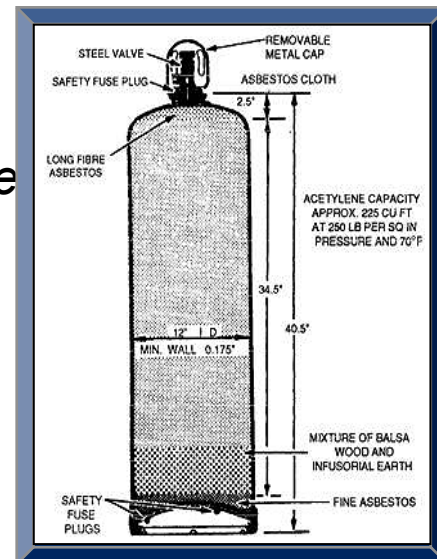

Cylinders for Liquefied Gases

- ▶ Low pressure cylinders (typically)
- ▶ Typically have two valves; one of gas, one for liquid
- ▶ Liquid valve usually has a dip tube running from valve to about $\frac{3}{4}$ " from cylinder bottom
- ▶ Gooseneck eductor tubes from valve and curve to
- ▶ Cylinder must be placed on its side to withdraw liquid through the valve

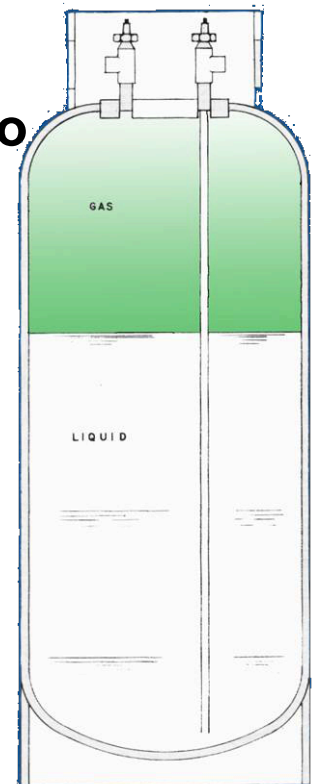
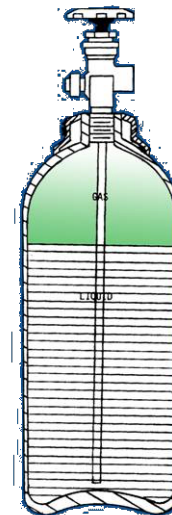
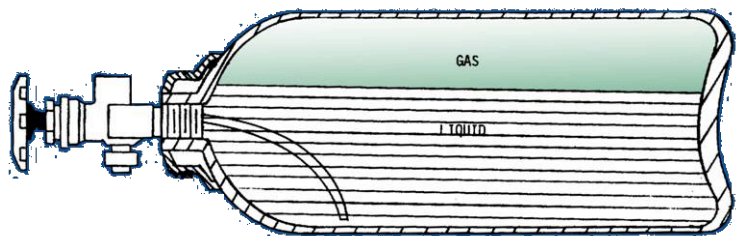

Cylinder Valves and Connections

▶ Packed

- Liquefied gases
- Corrosive gases
- Lower pressures

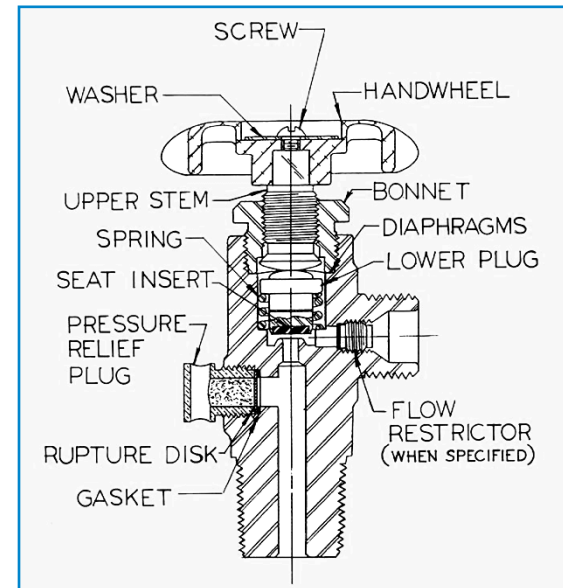
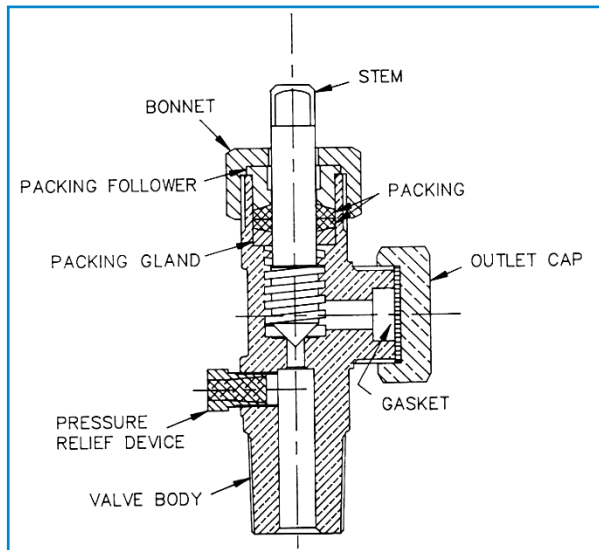

▶ Packless

- Pure gases and mixtures
- Higher pressure gases
- Metal diaphragm separates two-piece stem

Common Cylinder Valves

- Methyl Bromide
- Ammonia
- Propane
- Acetylene
- Oxygen

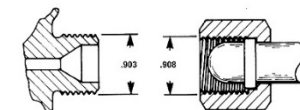
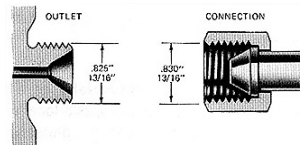
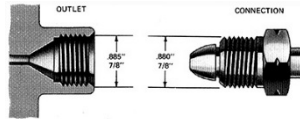
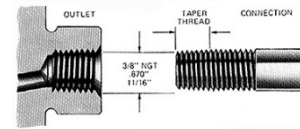
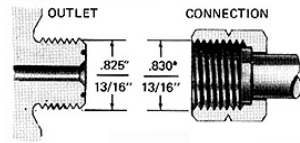

Pressure Relief Devices

- ▶ A pressure and/or temperature activated device designed to prevent the catastrophic failure of a compressed gas cylinder due to pressure build-up.
- ▶ Compressed Gas Association has designated 6 basic configurations:
 - CG-1 Pressure Relief Rupture Disk
 - CG-2 Fusible Plug (melting point 165 F)
 - CG-3 Fusible Plug (melting point 212 F)
 - CG-4 Combination Rupture Disk/Fusible Plug (melting point 165 F)
 - CG-5 Combination Rupture Disk/Fusible Plug (melting point 212 F)
 - CG-7 Spring-loaded
- ▶ Specific gases are assigned specific relief devices
- ▶ Relief devices may be located in valve or in cylinder-body
- ▶ Cylinders in Hazardous Zone A poisons are not equipped with relief devices
- ▶ Some gases (such as the freons) are not required to have relief devices.

Pressure Relief Devices

- ▶ **CG-1 Pressure Relief Rupture Disk (Frangible D**

Ruptures when there is excess pressure inside cylinder caused by overfilling or heating.

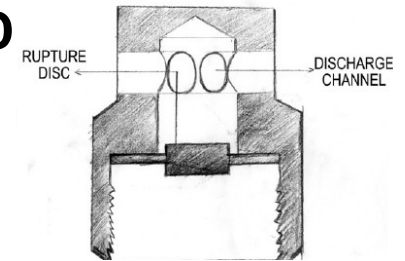

- ▶ **CG-2 Fusible Plug (melting point 165 F), CG-3 Fusible Plug (melting point 212 F)**

Melts when there is excessive heat caused by heating or fire.

May extrude from housing under hot conditions

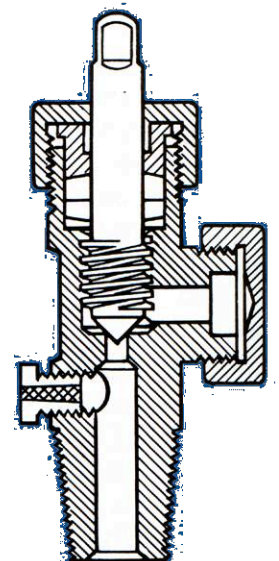
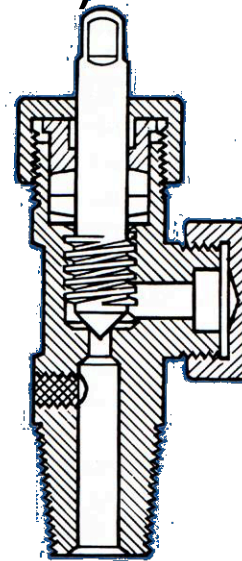

Pressure Relief Devices

- ▶ **CG-4/5 Combination Rupture Disk/Fusible Plug**

Fusible plug melts first (from heating) then rupture disk fails due to pressure.

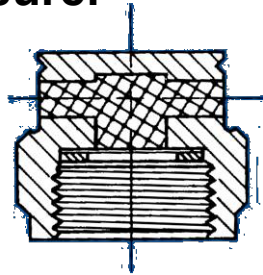

- ▶ **CG-7 Spring Relief Device**

Activates then re-seats to prevent further venting. Used on flammable gas cylinders.

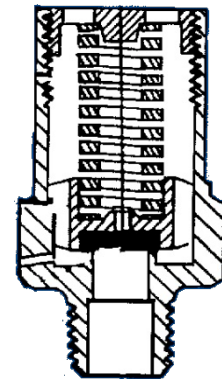
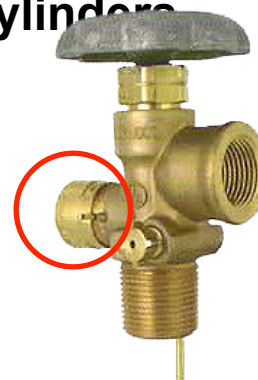

Valve Connections

- ▶ Designed to ensure a gas-tight seal and prevent mixing of different gas types
- ▶ Connections specified by Compressed Gas Association
- ▶ Variation between connections include:
 - Connection shape
 - Gender
 - Size
 - Left or right-hand threads

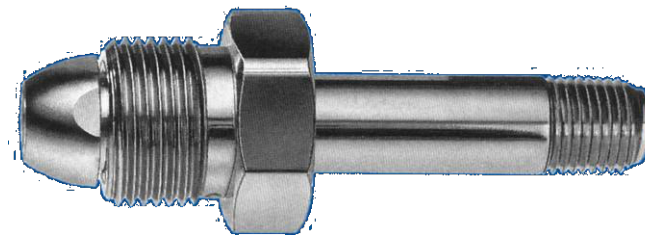
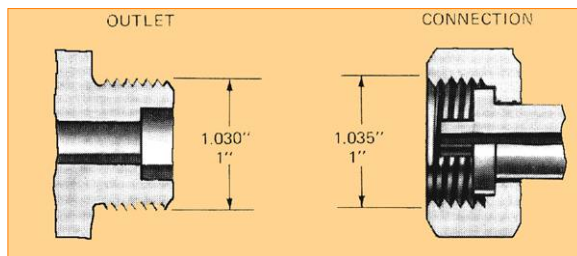
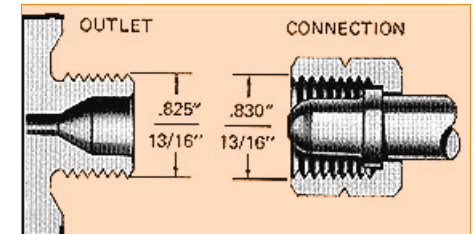

Defects and Damage

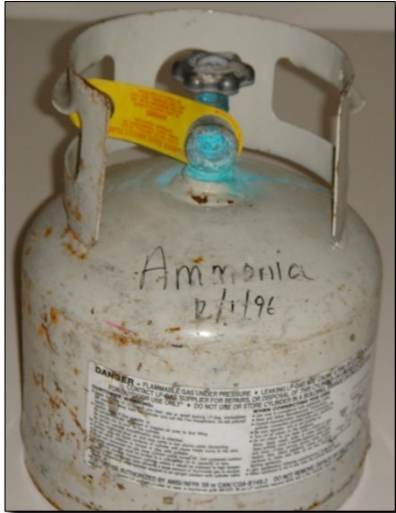

Personal Protective Equipment

Personal Protective Equipment includes:

- Hardhat
- Gloves
- Coveralls
- Safety Glasses
- Steel-toed Work Boots
- Pants
- Ear plugs (when working around loud equipment)
- Respirator



Emergency Procedures

Leaks

- ▶ Place leaking cylinder into overpack (unless it is acetylene).
- ▶ If leakage is from valve outlet, gently tighten valve stem. If increasing closure torque does not stop leak, sealing seat is likely damaged and cylinder should be placed into overpack.
- ▶ If leakage is around valve stem, loosen gland nut (if present) then gently tighten the gland nut back about $\frac{1}{4}$ turn. (Note: All gland nuts have right-hand threads). This can only be done on packed valves.
- ▶ If leakage is around valve/cylinder connection, cylinder should be placed into overpack or fitted with a capping kit/containment bag.
- ▶ Isolate or enclose leaking cylinder and vent gas into scrubber.
- ▶ Transfer cylinder contents or dispose directly into scrubber.

Emergency Procedures

Fire

- ▶ Move cylinders away from fire.
- ▶ If cylinders cannot be moved, spray with water to keep

Relief devices will fail if overheated or overpressurized leading to a large-scale gas release!

- ▶ Fires fed by cylinders venting flammable gas are extremely difficult to extinguish.
- ▶ To the extent possible remove other cylinders and flammable material from around a venting cylinder.
- ▶ Always use SCBA when responding to cylinder leaks or fires.

Emergency Procedures

Inoperable Valve

- ▶ Avoid unnecessary movement.
- ▶ Process immediately or place into pressure containment
 - Cylinder Management Device
 - Saddle and Penetrator
 - Cryogenic Revalving
 - On-site overpack (cylinder processed on site)
 - DOT-exempt salvage cylinder (cylinder shipped off site)
- ▶ Look for bent, deformed, or scarred valve stems and discoloration
- ▶ Always verify free flow through valve into cylinder (blockage may be in valve throat, especially with corrosive materials)
- ▶ Always de-pressurize cylinders very slowly, listening for escaping gas.



Specialized Handling Equipment

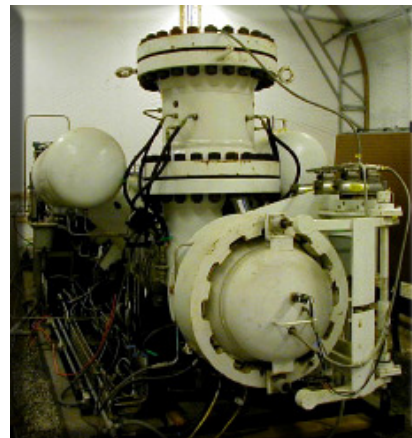
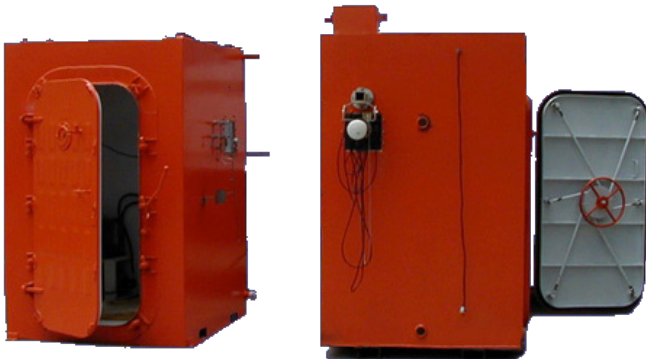
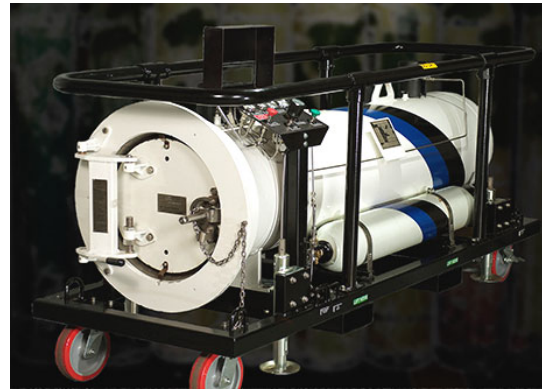

General Methodology

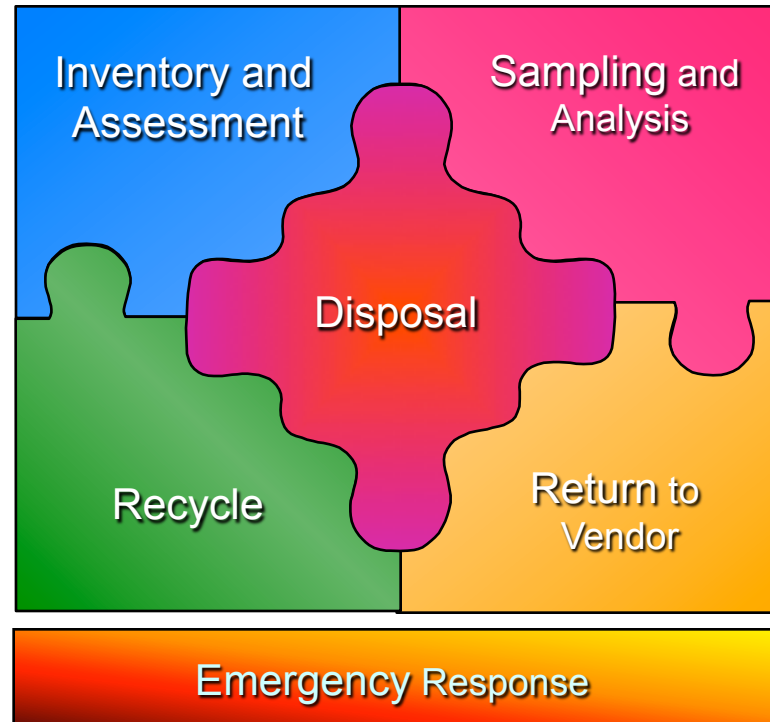

Inventory and Assessment

- Visual Assessment
 - Cylinder body
 - Cylinder base
 - Valve
- Photographs
 - Cylinder
 - Valve
 - Valve opening
- Damage notation
 - Physical damage: Cylinder body/Valve
 - Signs of Leakage

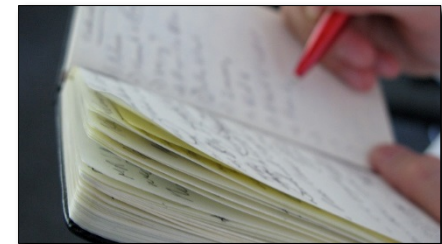

Result?



Sampling

- ▶ **Cylinder contents must be verified**
- ▶ **Verification options**
 - 100% of cylinders sampled
 - 10% sampling of bulk cylinder groups with consistent valves and markings
- ▶ **Sampling options**
 - Syringe (Mass Spec)/Cell (FTIR)
 - Valve Sampling System
 - Sample cylinder

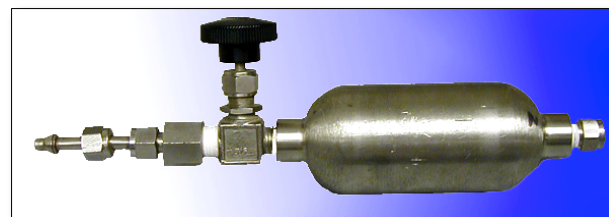
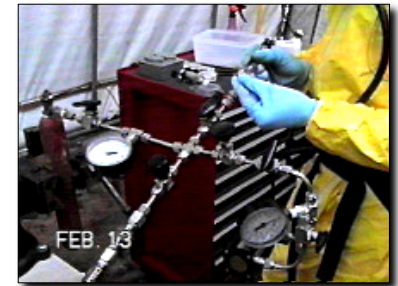

Sampling Logic

Operable vs. Inoperable Valve

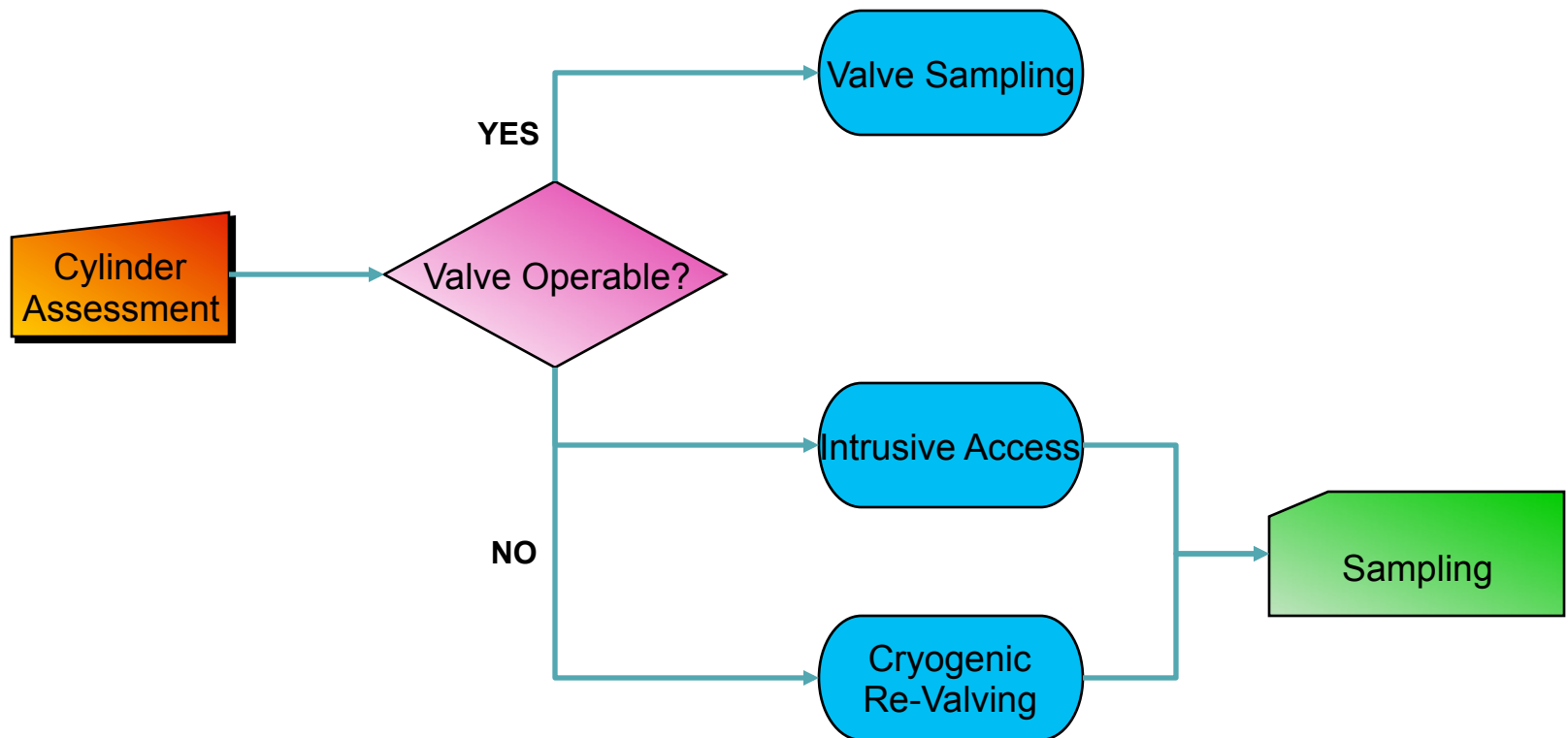

Identification Methodology

Known vs. Unknown

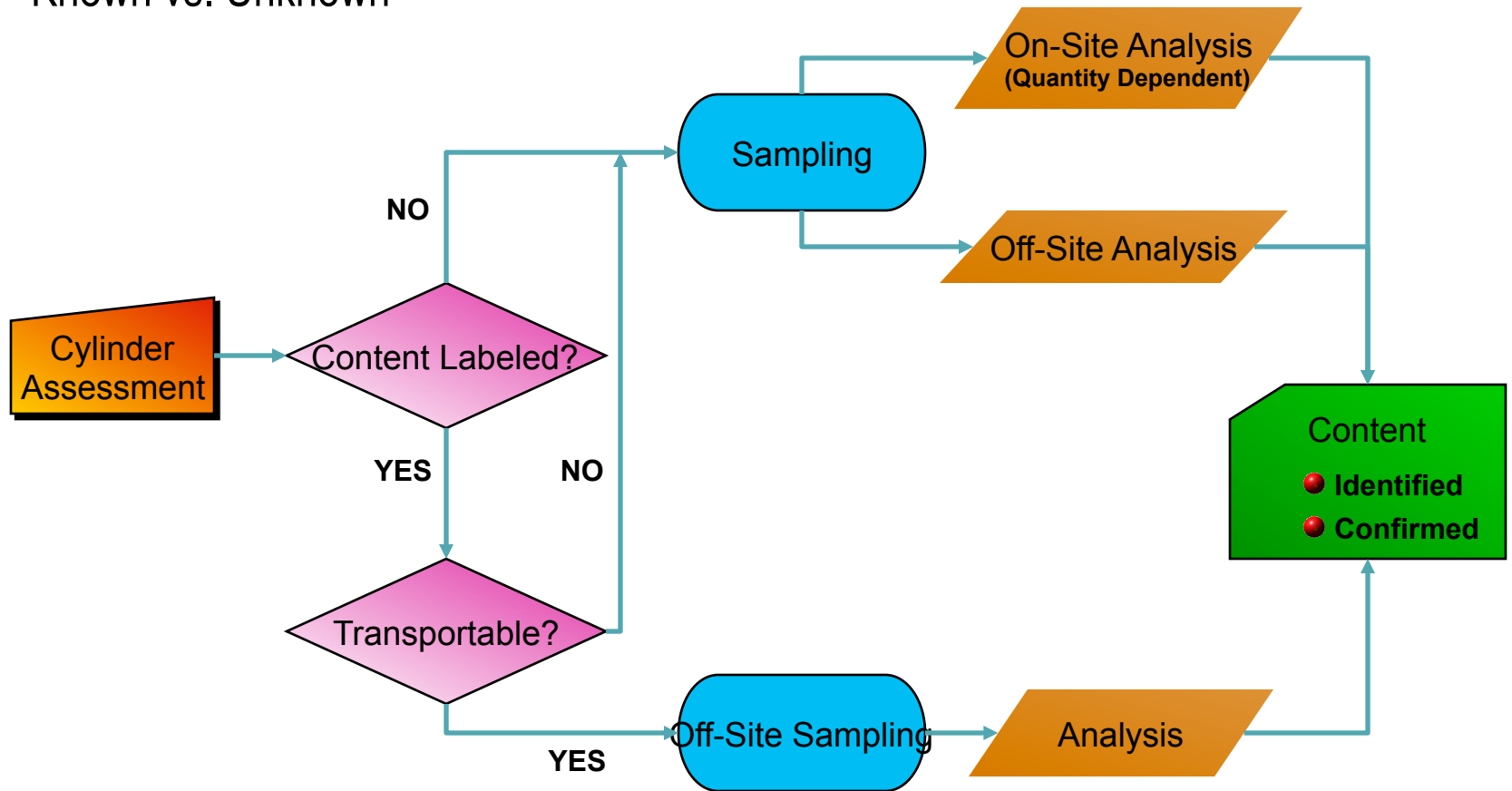

Processing Overview

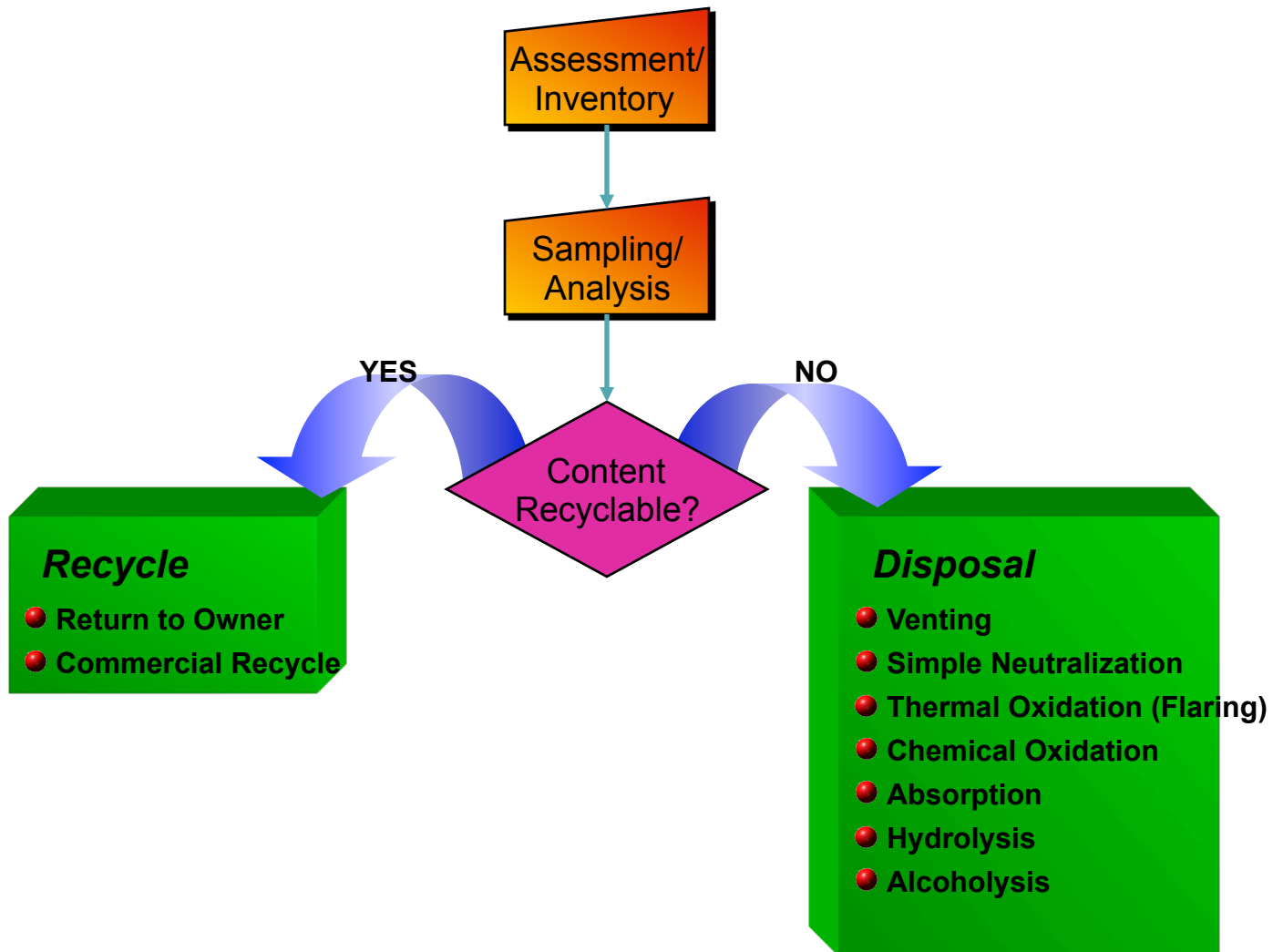

Cylinder Content Labeling

Transport under DOT regulations requires:

- ▶ **Name of material inside the cylinder from DOT list found in 49 CF**
 - Examples: Ammonia, anhydrous
- ▶ **Clear and legible markings**
 - Stencils, stamps, or labels

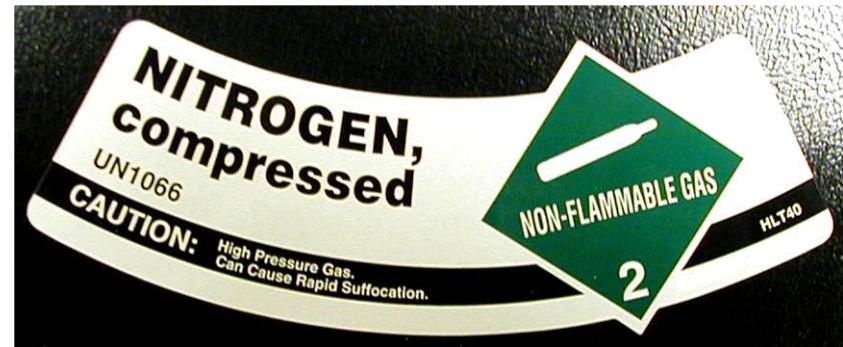

Note: Some gas suppliers use color-coding as a secondary means of identifying cylinder content. Good Idea??

DOT Hazard Labels

Compressed gases are divided into hazard classes which indicate the chief hazard involved in transporting the material.

Compressed gas cylinder hazard classes are:

- ▶ Flammable gas
- ▶ Non-flammable gas
- ▶ Poison gas
- ▶ Corrosive
- ▶ Oxidizer
- ▶ Flammable liquid
- ▶ Radioactive material



★ *Labeling is required whenever cylinders are transported.*

Key Points To Remember!

- ▶ **Cylinders that have been physically damaged, submerged, burned, or buried are probably deteriorated and must be handled very carefully.**
- ▶ **Do not rely on a cylinder's color as a key to identification.**
- ▶ **Physical structure and valve configuration are keys to identifying unknown cylinders.**
- ▶ **Unknown cylinders may not be legally transported unless overpacked.**
- ▶ **Even common gases such as oxygen and acetylene can pose serious hazards.**
- ▶ **When a gas is heated, its pressure increases or its volume increases.**
- ▶ **Cylinders and the gases they contain pose unique hazards and must be handled very carefully....every time!**

Contact Information

Integrated Environmental Services, Inc.

1445 Atlanta, GA 30318

404-352-2001

www.iescylinders.com



Precision Technik, Inc.

1445 Atlanta, GA 30318

404-693-8388

www.precisiontechnik.com

